

Hlavice HRV rotující semiradiálně směrem dopředu

Hlavice HRH **enz golden jet**® rotují semiradiálně směrem dopředu. Úhel, pod kterým trysky stříkají vodní paprsek na stěnu potrubí, je ca. 45°. Na přání se dodávají hlavice s tryskou stříkající vodní paprsek směrem dopředu. Hlavice je dále vybavena třemi zpětnými tryskami pro dosažení rotačního šroubovitého pohybu hlavice, který účinně napomáhá čištění ucpaného potrubí. Čelní trysky uvolňují nečistoty, semiradiální trysky rozrušují zbytky nečistot, zpětné trysky pohybují hlavici směrem dopředu, a současně odplavují uvolněné nečistoty směrem dozadu.

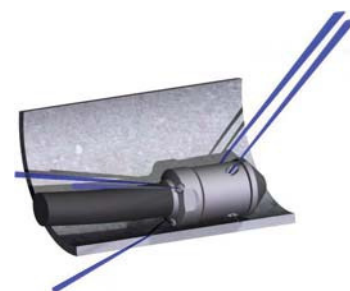

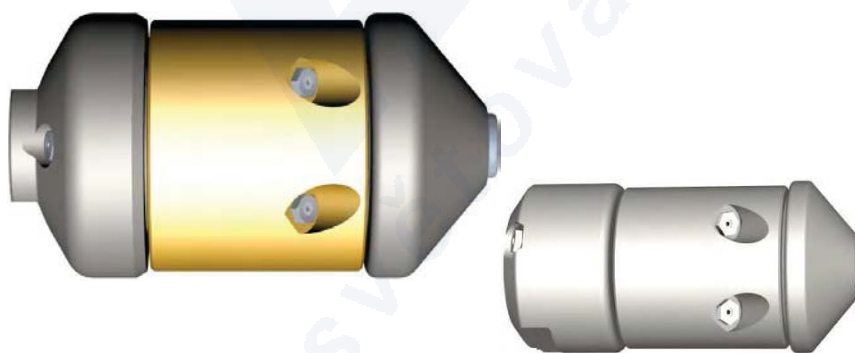









Použití:

- Proplachování středu ocelového potrubí během hydraulického odvrtávání nečistot
- Čištění domovních přípojek z domu směrem do odbočky
- Odstraňování ledu z šachet a potrubí

















Hlavice HRV rotující semiradiálně směrem dopředu

Hlavice HRV rotující semiradiálně směrem dopředu 1/4" - 3/4"

				
	1/4	1/2	1/2	3/4
	30 - 100	70 - 150	100 - 200	
	30	50	70	
	4 × M4	4 × M6	4 × M6	
	3 × M4	3 × M6	3 × M6	
	*	*	*	
	ØxL 28 × 56	40 × 80	50 × 99	
	0.200	0.560	1.100	
	350			250
	—	—	—	

Hlavice HRV rotující semiradiálně směrem dopředu 1" - 1 1/4"

			
	1	1	1 1/4
	100 - 300	200 - 600	
	100	200	
	4 × M8	4 × M10	
	3 × M8	3 × M10	
	*	*	
	ØxL 60 × 111	100 × 180	
	1.600	7.400	
	250		
	—	—	

	Spojovací závit ["]		Tlačný paprsek kapaliny		Recyklace		Maximalní tlak [bar]
	Rozsah použití [mm]		Čelní paprsek kapaliny		Rotační hlavice (trysky)		Možnost výběru
	Min. l/min při tlaku 100bar		Rozměry [mm]		Váha [kg]		