

3007

Telehandlers > 6,0 m



The telehandler 3007 - a compact allrounder

The Kramer telehandler 3007 is a compact all-round talent – its low overall height, small turning radius combined with a lifting height of 7 metres and 3 tonnes of payload provide outstanding versatility. A variable drive system and cleverly designed access for routine maintenance ensure easy day to day operation. The ergonomic and functional cab ensures stress-free working. The different working modes of the Smart Handling overload system offer safety and comfort.

- 3.0 tonne of payload and 7 metres lift height
- Low fuel consumption and high torque (90 kW Deutz, emissions level 3b)
- Variable hydrostatic transmission
- Very spacious panoramic cab provides maximum driver comfort and superb all-round visibility
- Compact dimensions for easy working in tight spaces

3007

Telehandlers > 6,0 m

Technical specifications

Operating data

Bucket capacity (standard bucket)	1 m ³
Operating weight (without add-on equipment)	6,700 kg

Engine / Motor

Engine / Motor manufacturer	Deutz
Engine performance	90 kW

Power transmission

Travel speed	20 km/h
--------------	---------

Steering and operating hydraulics

Flow rate (pump)	100 l/min
Pressure (maximum)	260 bar

Kinematics

Payload (LSP = 500 mm)	3,000 kg
Payload (for max. lifting height)	2,000 kg
Payload (for max. range)	1,000 kg

Additional technical data is available in the detailed brochure within the informational material section

Dimensions

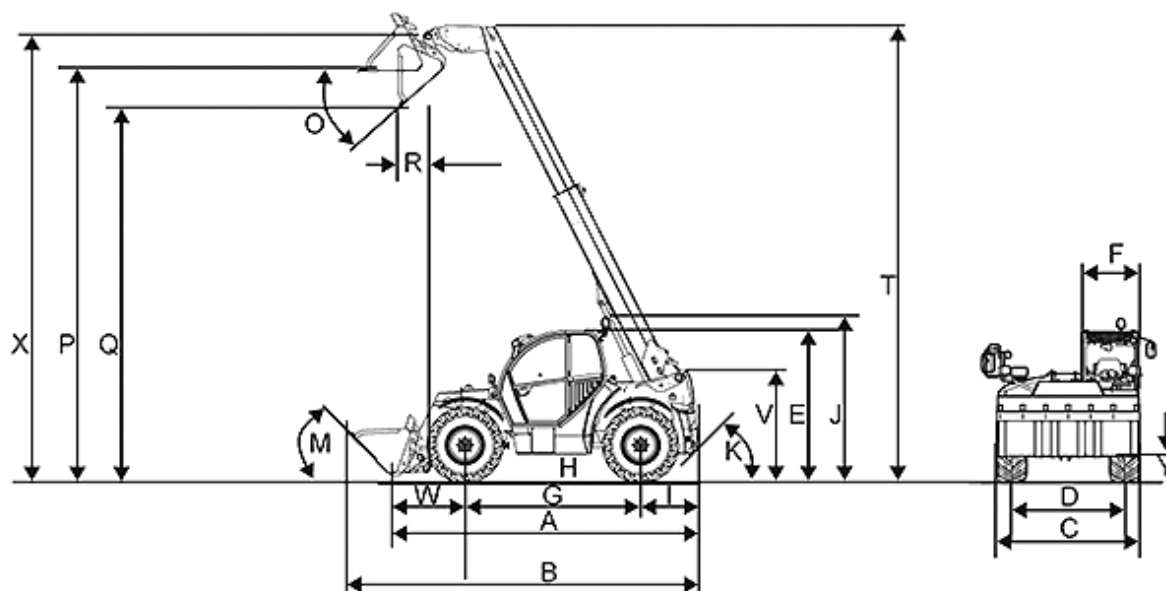

A	Length incl. tool frame	4,880 mm
B	Length with standard bucket	5,600 mm
C	Width with standard tyres	2,280 mm
D	Track width	1,880 mm
E	Height to cabin roof	2,290 mm
F	Inside width (w/o wheels) (width of the cabin)	990 mm
G	Wheelbase	2,850 mm
H	Ground clearance	415 mm
I	Center of rear axle to end of vehicle	830 mm
K	Rear actuation angle	45 °
M	Tipping angle (bucket)	49 °
O	Tip-out angle (bucket)	41 °
P	Overhead loading height (with standard bucket)	6,820 mm

Q	Dumping height	6,330 mm
R	Dump reach	110 mm
	Stack height	7,000 mm

Information on suitable accessories can be found on our website.

The right to make changes is reserved in the interests of ongoing further developments. You can find more information on the engine power in the operator's manual. The actual power output figures may vary due to specific operating conditions.

Information on suitable accessories can be found on our website. More detailed information on engine power can be found in the operator's manual; the stated power may vary due to specific operating conditions. Subject to alterations and errors excepted. Applicable also to illustrations. Copyright © 2015 Kramer-Werke GmbH.